



CDMA Portable Cellular Telephone

SCH-570

SECRET

SERVICE Manual

CDMA Portable Cellular Telephone



CONTENTS

1. General Introduction
2. Specification
3. NAM Programming
4. Data Transfer
5. Circuit Description
6. Exploded View and Its Parts List
7. PCB Diagrams
8. Troubleshooting
9. Test Command Table
10. Block & Circuit Diagrams



1. General Introduction

The SCH-570 cellular phone functions as only digital cellular phone working in CDMA (Code Division Multiple Access) mode. CDMA type digital mode applies DSSS (Direct Sequential Spread spectrum) mode which first came to be used in the military.

The DSSS reduces channel cross talk and allow to use one frequency channel by multiple users in the same specific area, resulting in increase of channel capacity to about ten times compared to that of analog mode currently used.

Soft/Softer Handoff, Hard Handoff, and Dynamic RF Power Control technologies are combined into this phone to reduce the call drop while usage.

CDMA digital cellular network consists of MSO (Mobile Switching Office), BSC (Base Station Controller), BTS (Base Station Transmission System), and MS (Mobile Station). MS meets the specifications of the below:

- IS-95A : Mobile Station-Base Station Compatibility Standard for Dual-Mode Wideband Spread Spectrum Cellular System
- IS-96A : Speech Service Option 1 Standard for Dual-Mode Wideband Spread Spectrum Cellular Systems
- IS-98A : Standards for Dual-Mode Wideband Spread Spectrum Cellular Mobile Station
- IS-126 : Mobile Station Loopback Service Options Standard

SCH-570 is composed of main handset, desktop charger, standard battery.

1.1 General

• Frequency Range	
Transmitter	: 824.64 ~ 848.37 MHz
Receiver	: 869.64 ~ 893.37 MHz
• Channel Spacing	: 1.23 MHz
• Number of Channels	: 20 FA
• Duplex Spacing	: 45 MHz

● MSC Transmitter Frequency

FA NO.	CH. NO.	CENTER FREQUENCY	FA NO.	CH. NO.	CENTER FREQUENCY
1	1011	824.640MHz	11	404	837.120MHz
2	29	825.870MHz	12	445	838.350MHz
3	70	827.100MHz	13	486	839.580MHz
4	111	828.330MHz	14	527	840.810MHz
5	152	829.560MHz	15	568	842.040MHz
6	193	830.790MHz	16	609	843.270MHz
7	234	832.020MHz	17	650	844.270MHz
8	275	833.250MHz	18	697	845.910MHz
9	316	834.480MHz	19	738	847.140MHz
10	363	835.890MHz	20	779	848.370MHz

● MSC Receiver Frequency

FA NO.	CH. NO.	CENTER FREQUENCY	FA NO.	CH. NO.	CENTER FREQUENCY
1	1011	869.640MHz	11	404	882.120MHz
2	29	870.870MHz	12	445	883.350MHz
3	70	872.100MHz	13	486	884.580MHz
4	111	873.330MHz	14	527	885.810MHz
5	152	874.560MHz	15	568	887.040MHz
6	193	875.790MHz	16	609	888.270MHz
7	234	877.020MHz	17	650	889.270MHz
8	275	878.250MHz	18	697	890.910MHz
9	316	879.480MHz	19	738	892.140MHz
10	363	880.890MHz	20	779	893.370MHz

2. Specification

Frequency Range Transmitter	: 824.64 MHz ~ 848.37MHz
Frequency Range Receiver	: 869.64 MHz ~ 893.37 MHz
Waveform Quality	: above 0.944
Time Reference	: within \pm 1uS
RX Sensitivity	: - 104 dBm, FER = within 0.5%
Dynamic Range	: - 104 dBm ~ - 25 dBm, FER = within 0.5%
TX Output Power	: Maximum 320 mW (25dBm)
TX Frequency Deviation	: within \pm 300 Hz
Occupied Band Width	: 1.32 MHz
TX Conducted Spurious Emissions	: 900 kHz below - 42 dBc / 30 kHz : 1.98 MHz below - 54 dBc / 30 kHz
Minimum TX Power Control	: below - 50 dBm
Open Loop Power Control	: - 25 dBm : - 57.0 dBm ~ - 38.5 dBm - 65 dBm : - 17.5 dBm ~ + 1.5 dBm - 104 dBm : + 18.0 dBm ~ + 30.0 dBm
Stand-by Output Power	: below - 61 dBm
Closed Loop TX Power Control Range	: Test 1 within \pm 24 dB Test 2 0 ms ~ 2.5 ms Test 3 within \pm 24 dB Test 4 within \pm 24 dB Test 5 within \pm 24 dB
Size (mm)	: 108 × 46 × 25 (Standard battery)
Weight (g)	: 128 (1000mA Standard battery)

5. Circuit Description

5-1 Logic Section

5-1-1 Power Supply

With the battery installed on the phone and by pressing the END/Ⓚ key, the VBATT and ON_SW signals will be connected. This will turn on U123 DC_DC convertor.

This in turn will be supplied to PIN3, PIN4 of regulators U124, PIN6 of regulators U122, thus releasing them from the shut-down state to output regulated 3.3V. (The VBATT applied to ON-SW will turn on Q103(DTC144EE) resulting in the signal ON_SW_SENSE to change the start from High to Low.)

The MSM recognizes this signal and sends out PS_HOLD (logical HIGH) to turn on Q102 even after the PWR key is released.

The power from U124 is used in the digital part of MSM and BBA. The power from U122 is used in analog part of BBA.

5-1-2 Logic Part

The logic part consists of internal CPU of MSM, RAM, ROM and EEPROM. The MSM receives TCXO and CHIPX8 clock signals from the BBA and controls the phone during the operation. The major components are as follows:

- CPU : INTEL 80186 core (inside the MSM)
- FLASH ROM : U701 - 8 Mbit FLASH MEMORY
- SRAM : U703 - 2 Mbit STATIC RAM
- FLASH ROM : U702 - 1 Mbit FLASH MEMORY
- EEPROM : U102 - 128 Kbit SERIAL EEPROM

CPU

INTEL 80186 CMOS type 16-bit microprocessor is used for the main processing. The CPU controls all the circuitry. For the CPU clock, 27MHz resonator is used.

FLASH ROM

One 8 MBIT FROM is used to store the terminal's program. Using the down-loading program, the program can be changed even after the terminal is fully assembled.

SRAM

One 2 MBIT SRAM is used to store the internal flag information, call processing data, and timer data.

EEPROM

One 128 KBIT EEPROM is used to store ESN, NAM, power level, volume level, and telephone number.

KEYPAD

For key recognition, key matrix is to set up using SCAN0-6 of STORE signals and KEY0-3 of input ports of MSM. Ten LEDs and backlighting circuitry are included in the keypad for easy operation in the dark.

LCD MODULE

LCD module contains a controller which will display the information onto the LCD by 8-bit data from the MSM. It also consists a DC-DC converter to supply -3.5V for fine view angle and LCD reflector to improve the display efficiency.

5-1-3 Baseband Part

MOBILE STATION MODEM (MSM)

The MSM equipped with the INTEL 80186 CPU core is an important component of the CDMA cellular phone. The MSM comes in a 176 pins TQFP package.

MICROPROCESSOR INTERFACE

The interface circuitry consists of reset circuit, address bus (A0-A19), data bus (AD0-AD15), and memory controls (ALE, DT_R, HWR/, LWR/, RAM_CS/, ROM_CS etc).

INPUT CLOCK

- CPU clock: 27 MHz
- TCXO/4 (pin 34): 4.92 MHz. This clock signal from the BBA is the reference clock for the MSM except in CDMA mode.
- CHIPX8 : 9.8304 MHz. The reference clock used during the CDMA mode.

BBA INTERFACE

CDMA, FM Data Interface

- TXIQDATA0-7 (pins 24-32) : TX data bus used during both CDMA and FM mode but it is used only for CDMA mode at this phone.

Clock

- TC_CLK (pin 22), TX_CLK/(pin 23) : Digital to Analog Converter (DAC) reference clock used in CDMA TX mode.
- CHIPX8 : ADC reference clock used in CDMA RX mode.

ADC Interface

ADC_CLK (pin 3), ADC_ENABLE (pin 1) and ADC_DATA (pin 2) are required to control the internal ADC in the BBA.

Data Port Interface

Includes the UART. Also, supports Diagnostic Monitor (DM), HP equipment interface, down loading, and data service.

CODEC Interface

The MSM sends 2.048 MHz PCM_CLK (pin 19) and 8 KHz PCM_SYNC (pin 16, 20) to the CODEC (U117). The voice PCM data from the MSM (U101) PCM_DIN (pin 135) is compressed into 8 KHz, by QCELP algorithm in the CDMA mode.

RF Interface

TX : TX_AGC_ADJ (pin 35) port is used to control the TX power level and PA_ON (pin 44) signal is used to control the power amplifier. This signal depends on the TX vocoder rate.

RX : AGC_REF (pin 36) port is used to control the RX gain and TRK_LO_ADJ (pin 45) is used to compensate the TCXO clock.

General Purpose I/O Register Pins

Input/output ports to control external devices.

Power Down Control

When the IDLE/ signal turns to LOW, only the TX sections will be disabled. If both the IDLE/ and SLEEP/ change to LOW, all the pins except for the TCXO and 27MHz clock are disabled.

5-1-4 Audio Part

TX AUDIO PATH

The voice signal output from microphone is filtered and amplified by the internal OP-AMP and is converted to PCM data by the CODEC (U117). The signal is then applied to the MSM (U101)'s internal vocoder.

RX AUDIO PATH

The PCM data from the MSM's converted to audio signal by ADC of CODEC (U117), is then amplified by the speaker amplifier (U111) to be sent to the speaker unit.

TX WBD, ST, SAT

These signals are generated from MSM. The modulation level of TX WBD and ST is ± 8 kHz/dev, and SAT is ± 2 kHz/dev.

BUZZER DRIVING CIRCUITRY

Buzzer generates alert tone when the buzzer receives the timer signal from the MSM, it generates alert tone. The buzzer level is adjusted by the alert signal's period generated from the MSM timer.

KEY TONE GENERATION

Ringer signal (pin49) out from MSM (U101) is passed through 2 serial LPF consisting of R141, C146, R145, and C142 amplified at the speaker amp (U111), and comes out to speaker.

5-2 Receiver Section

LOW NOISE AMPLIFIER (LNA, Q302)

The low noise amplifier amplifies a weak signal received from the base station to obtain the optimum level (Noise figure = 1.5 dB, Gain = 16 dB).

IF SAW BAND PASS FILTER (FOR CDMA)

IF SAW BPF (F303) is used for CDMA system having 1.23 MHz wideband and ± 630 kHz bandwidth. The filter also attenuates the image product generated at the mixer.

RADIO FREQUENCY BAND PASS FILTER (RF BPF, F302)

The RF BPF accepts only a specific frequency (881 ± 12.5 MHz) from the signal received from the base station. The band width is 25 MHz.

BUFFER AMP (Q304)

Buffer (Q304) amplifies signal to be applied to the local input of the down converter (U301) when a phase is locked between VCO (U341) and PLL IC (U342).

DOWN CONVERTER (MIXER, U301)

First local signal is applied to this down converter. The down converter transfers the signal amplified at the LNA into 85.38 MHz IF signal. 85.38 MHz IF signal is made by subtracting 881 ± 12.5 MHz RF signal from 966 ± 12.5 MHz first local signal.

AUTOMATIC GAIN CONTROLLER (AGC) AMP (Q302)

85.38 MHz IF signal is applied to IF AGC amp, the IF AGC output level is applied to BBA (Baseband Analog ASIC). The IF AGC amp (Q302) keeps the signal at a constant level by controlling the gain. Dynamic range is 90dB, up gain +45dB, and down gain -45dB.

VOLTAGE CONTROLLED OSCILLATOR (VCO, U341)

The VCO (U341) generates the signal having 966 MHz center frequency and ± 12.5 MHz deviation with the voltage control. PLL IC (U342) controls this signal.

ANTENNA

Antenna allows signals and sends to receive from the base station.

PHASE LOCKED LOOP (PLL, U342)

Input reference frequency is generated at VC_TCXO (U343) and the divided signal is generated at VCO. PLL compares the two signals and generates the desired signal with a pre-programmed counter which controls voltage.

VOLTAGE CONTROLLED TEMPERATURE COMPENSATED CRYSTAL OSCILLATOR (VC-TCXO, U343)

It provides 19.68 MHz reference frequency to PLL. A correct frequency tuning is made by the voltage control.

DUPLEXER (F301)

Duplexer (F301) controls to transmit through the antenna only the signals within acceptable Tx frequency range (836 ± 12.5 MHz) and to receive through the antenna only the signals within acceptable Rx frequency range (881 ± 12.5 MHz). It also matches LNA input in receiving part and PA output in transmitter part with the antenna.

POWER SUPPLY REGULATOR (U123)

The power supply regulator generates a regulated power.

THERMISTOR (R498)

The thermistor (R498) detects temperature. It is used to compensate active component characteristics due to the temperature difference.

5-3 Transmitter Section

BBA (U401)

BBA (U401) consists of ADC, DAC, LPF (CDMA), divider, VCO, logic control circuit, PLL, and mixer.

BBA performs a specific function between RF part and logic part, with MSM. The IF signal out from Rx IF AGC amp is secondly converted through the down-converter. The signal passes through the CDMA or FM filter, converts to digital signal through ADC, then is sent to MSM. The digital signal out from MSM converts to analog signal through each filter and the up-converters.

POWER AMP MODULE (U467)

Power Amp module (U467) amplifies signal (24dB Gain) to be sent out to the base station through the antenna.

UP CONVERTER (MIXER, U460)

The up-converter (U460) receives the first local signal to generate 836 ± 12.5 MHz from the BBA. 836 ± 12.5 MHz signal comes out of the mixer output by subtracting 130 MHz IF signal from 966 ± 12.5 MHz first local signal.

RF AUTOMATIC GAIN CONTROLLER AMP (U461, U464)

The signal out to the base station should be a constant level. The TX RF AGC amp controls power to keep the signal at a constant level.

RF BAND PASS FILTER (BPF, F451)

The RF BPF (F451) accepts only a specific frequency (836 ± 12.5 MHz) to send it out to the base station. The band width is 25 MHz.

POWER SUPPLY SWITCHING (U484)

Power supply switching (U484) turns on TX_POWER when the phone is in traffic mode and supplies power to the circuits.

POWER SUPPLY REGULATOR (U482, U483)

The power supply regulators (U482,U483) supply a regulated power to each part of transmitter. U482 supplies 3.6V to TX AGC amp (U461) and up-converter (U460). U483 supplies 3.0V to power amp module control circuit (U487).

6. Exploded View and its Parts List

6-1 Fixed Phone Exploded View

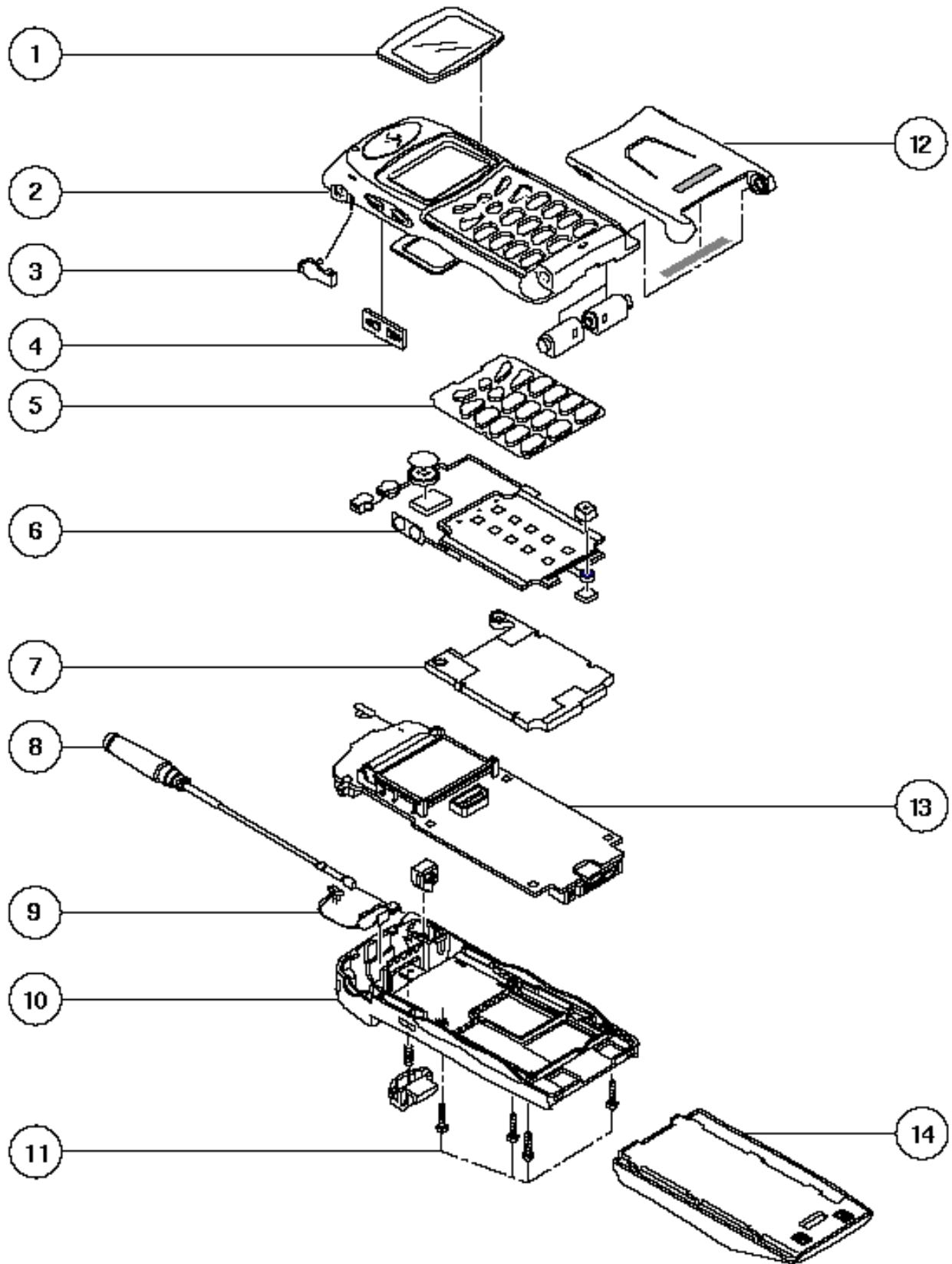

6-2 Fixed Phone Parts List

NO	DESCRIPTION	SEC CODE			REMARK
		Black	Golden Beige	Dark Pink	
1	Front Window	GH72 - 41585C	GH72 - 41585D	GH72 - 41585C	
2	SUB Front Case	GH75 - 11193E	GH75 - 11193F	GH75 - 11193G	
3	Earphone Dummy	GH72 - 41547A	GH72 - 41547B	GH72 - 41547A	
4	Volume Key	GH64 - 10016A	GH64 - 10016B	GH64 - 10016A	
5	Key Pad	GH72 - 41586B	GH72 - 41586B	GH72 - 41586B	
6	Key Pad Ass'y	GH59 - 10167A	GH59 - 10167A	GH59 - 10167A	
7	Shield Can	GH72 - 41583A	GH72 - 41583A	GH72 - 41583A	
8	Antenna	GH42 - 10524A	GH42 - 10524A	GH42 - 10524A	
9	Motor Ass'y	GH59 - 10153A	GH59 - 10153A	GH59 - 10153A	
10	SUB Rear Cover	GH75 - 11194E	GH75 - 11194E	GH75 - 11194E	
11	Screw	6001 - 001046	6001 - 001046	6001 - 001046	
12	Flip Ass'y	GH75 - 11261D	GH75 - 11261E	GH75 - 11261D	
13	Main PBA	GH92 - 01164A	GH92 - 01164A	GH92 - 01164A	
14	Battery	GH43 - 10310A GH43 - 10108A	GH43 - 10310A GH43 - 10108A	GH43 - 10310A GH43 - 10108A	EXTENDED-LIFE BATTERY

6-3 Rapid Charger View

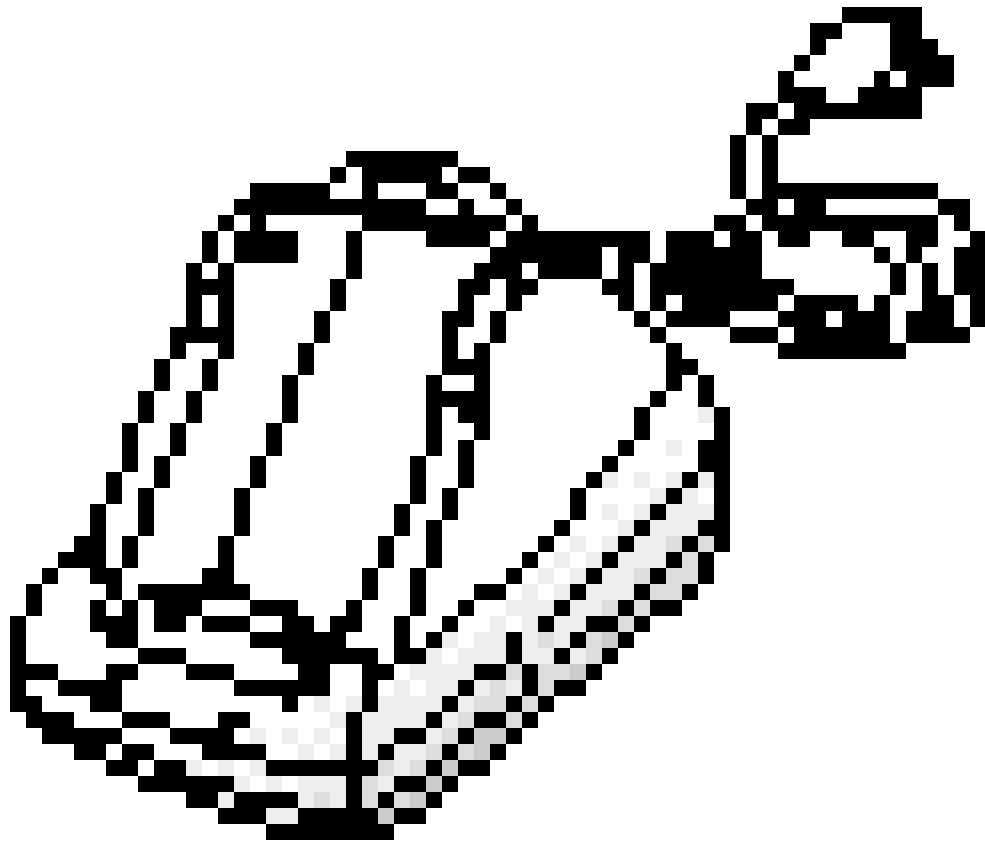

SEC CODE : GH44 - 40100A

7. PCB Diagrams

7-1 Cellular Phone

7-1-1 Main Board PCB: Top

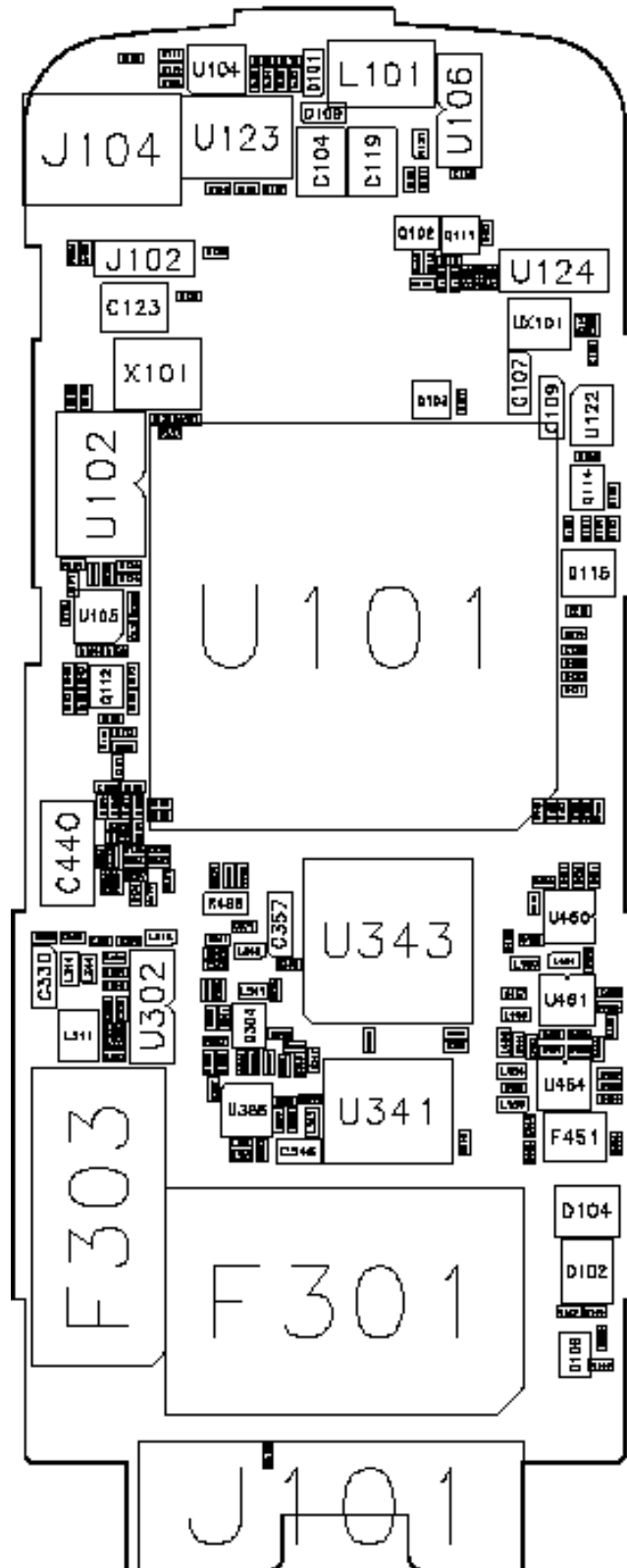

7-1-2 Main Board PCB: Bottom

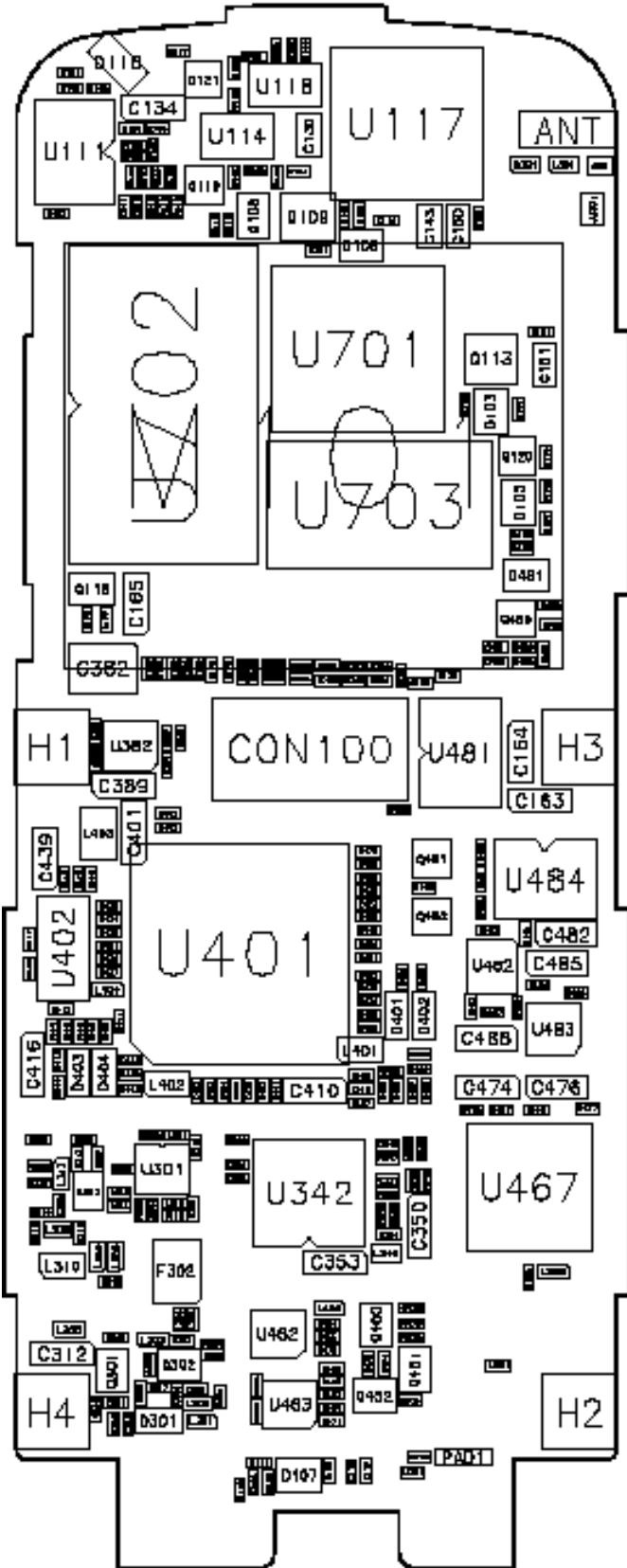

7-2 Electrical Parts List

SEC CODE	DESCRIPTION	PART NO.	REMARK
0401 - 001052	DIODE - SWITCHING	D101 D109	
0405 - 000107	DIODE - VARACTOR	D401 D402 D403 D404	
0407 - 000115	DIODE - ARRAY	D103 D105 D106	
0407 - 000122	DIODE - ARRAY	D102 D104	
0407 - 000127	DIODE - ARRAY	D107 D108 D481	
0409 - 000108	DIODE - PIN	D301	
0501 - 000162	TR - SMALL SIGNAL	Q116 Q450 Q452	
0501 - 000218	TR - SMALL SIGNAL	Q102 Q108 Q114 Q301	
0501 - 000218	TR - SMALL SIGNAL	Q451	
0501 - 000457	TR - SMALL SIGNAL	Q113 Q115	
0501 - 000689	TR - SMALL SIGNAL	Q304	
0501 - 002063	TR - SMALL SIGNAL	Q303	
0501 - 002208	TR - SMALL SIGNAL	Q109	
0504 - 000167	TR - DIGITAL	Q119 Q481 Q482	
0504 - 000168	TR - DIGITAL	Q103 Q121	
0504 - 000172	TR - DIGITAL	Q111 Q120	
0504 - 001016	TR - DIGITAL	Q485	
0501 - 001062	FET - GaAs	U301	
0505 - 001095	FET - SILICON	U106	
0505 - 001119	FET - SILICON	Q302	
0505 - 001165	FET - SILICON	U104	
0505 - 001170	FET - SILICON	U484	
0601 - 000355	LED - CHIP - RED	D116	
0801 - 000304	IC - CMOS - LOGIC	U105	
0803 - 003010	IC - TTL	U114	
0904 - 001183	IC - DSP	U201	
1001 - 001019	IC - ANALOG MULTIPLEX	U481	
1103 - 001062	IC - EEPROM	U102	
1106 - 001126	IC - SRAM	U702	
1106 - 001130	IC - SRAM	U703	
1107 - 001062	IC - SRAM	U701	

SEC CODE	DESCRIPTION	PART NO.	REMARK
1201 - 000103	IC - AUDIO AMP	U111	
1201 - 001006	IC - OP AMP	U462 U463	
1201 - 001090	IC - PREAMP	U385	
1201 - 001175	IC - PREAMP	U464	
1201 - 001176	IC - PREAMP	U461	
1201 - 001257	IC - AGC AMP	U302	
1201 - 001259	IC - POWER AMP	U467	
1202 - 000192	IC - CMOS COMPARATOR	U118	
1203 - 000392	IC - RESET	UX101	
1203 - 001107	IC - VOLTAGE REGULATOR	U482	
1203 - 001256	IC - VOLTAGE REGULATOR	U382	
1203 - 001268	IC - VOLTAGE REGULATOR	U124	
1203 - 001285	IC - SWITCH VOL.	U483	
1203 - 001390	IC - VOLTAGE REGULATOR	U122	
1203 - 001396	IC - PWM CONTROLLER	U123	
1204 - 001106	IC - ASP	U117	
1205 - 001253	IC - MIXER	U460	
1205 - 001383	IC - DATA COMM.	U101	
1205 - 001451	IC - DATA COMM.	U401	
1209 - 000142	IC - SYNTHESIZER	U342	
1209 - 001078	IC - PLL SYNTHESIZER	U402	
1404 - 001040	THERMISTOR - NTC	R498	
2007 - 000070	R - CHIP 0	L450	
2007 - 000137	R - CHIP 2 K 1/16 W	R417 R130	
2007 - 000138	R - CHIP 100 1/16 W	R154	
2007 - 000140	R - CHIP 1 K 1/16 W	R192 R205 R156 R158 R147	
2007 - 000140	R - CHIP 1 K 1/16 W	R132 R188 R346 R416 R451	
2007 - 000140	R - CHIP 1 K 1/16 W	R209 R345 R109	
2007 - 000141	R - CHIP 2.2 K 1/16 W	R128 R303	
2007 - 000142	R - CHIP 2.7 K 1/16 W	R456 R486 R141	
2007 - 000143	R - CHIP 4.7 K 1/16 W	R129 R145 R152 R173 R176	
2007 - 000143	R - CHIP 4.7 K 1/16 W	R466 R140 R411	
2007 - 000146	R - CHIP 6.8 K 1/16 W	R455	

SEC CODE	DESCRIPTION	PART NO.	REMARK
2007 - 000148	R - CHIP 10 K 1/16 W	R180 R182 R184 R185 R473	
2007 - 000148	R - CHIP 10 K 1/16 W	R157 R159 R143 R144 R702	
2007 - 000148	R - CHIP 10 K 1/16 W	R460 R178 R137R414 R485	
2007 - 000148	R - CHIP 10 K 1/16 W	R174 R305 R337 R406 R407	
2007 - 000148	R - CHIP 10 K 1/16 W	R413 R462 R464 R415 R496	
2007 - 000148	R - CHIP 10 K 1/16 W	U485 R701	
2007 - 000149	R - CHIP 12 K 1/16 W	R103 R104 U704	
2007 - 000151	R - CHIP 15 K 1/16 W	R208 R307	
2007 - 000152	R - CHIP 20 K 1/16 W	R133 R134	
2007 - 000153	R - CHIP 22 K 1/16 W	R119 R181 R131 R106 R189	
2007 - 000153	R - CHIP 22 K 1/16 W	R474	
2007 - 000155	R - CHIP 27 K 1/16 W	R463 R251 R252 R170	
2007 - 000155	R - CHIP 27 K 1/16 W	R136	
2007 - 000157	R - CHIP 47 K 1/16 W	R481 R482 R483 R484	
2007 - 000157	R - CHIP 47 K 1/16 W	R349 R139	
2007 - 000159	R - CHIP 56 K 1/16 W	R148	
2007 - 000162	R - CHIP 100 K 1/16 W	R122 R151 R153 R107 R171	
2007 - 000162	R - CHIP 100 K 1/16 W	R120 R116 R111 R112 R108	
2007 - 000162	R - CHIP 100 K 1/16 W	R110 R105 R123 R118	
2007 - 000164	R - CHIP 150 K 1/16 W	R114	
2007 - 000171	R - CHIP 0 1/16 W	R183 R216 R215 R364 R425	
2007 - 000171	R - CHIP 0 1/16 W	R408 R409 R165 R204 R418	
2007 - 000171	R - CHIP 0 1/16 W	C318 C155 R316 R422	
2007 - 000171	R - CHIP 0 1/16 W	R423 C444 C445 RX201 LX101	
2007 - 000172	R - CHIP 10 1/16 W	R306 R350 R347 R348 R356	
2007 - 000172	R - CHIP 10 1/16 W	R339 R341 R401 R419 R344	
2007 - 000173	R - CHIP 22 1/16 W	R468	
2007 - 000155	R - CHIP 27 K 1/16 W	R149	
2007 - 000772	R - CHIP 33 K 1/16 W	R121	
2007 - 000831	R - CHIP 39 K 1/16 W	R135 R177	
2007 - 000932	R - CHIP 470 1/16 W	R127 R155 R301	
2007 - 000982	R - CHIP 5.6 K 1/16 W	R362 R453 R454 R476	
2007 - 001119	R - CHIP 680 1/16 W	R355	

SEC CODE	DESCRIPTION	PART NO.	REMARK
2007 - 001217	R - CHIP 82 1/16 W	R186 R187	
2007 - 001244	R - CHIP 91 K 1/16 W	R102 R175	
2007 - 001288	R - CHIP 18 1/16 W	R360	
2007 - 001294	R - CHIP 36 1/16 W	R191 R193 R194 R336	
2007 - 001295	R - CHIP 39 1/16 W	R304	
2007 - 001305	R - CHIP 120 1/16 W	R467 R469	
2007 - 001306	R - CHIP 150 1/16 W	R361 R358 R309 R310	
2007 - 001307	R - CHIP 180 1/16 W	R217	
2007 - 001311	R - CHIP 270 1/16 W	R308 R357	
2007 - 001313	R - CHIP 330 1/16 W	RX102 RX501 RX502 RX503	
2007 - 001313	R - CHIP 330 1/16 W	RX504	
2007 - 001319	R - CHIP 1.2 K 1/16 W	R490 RX101 RX103	
2007 - 001320	R - CHIP 1.8 K 1/16 W	R410	
2007 - 001323	R - CHIP 3 K 1/16 W	R475	
2007 - 001325	R - CHIP 3.3 K 1/16 W	R190	
2007 - 001333	R - CHIP 18 K 1/16 W	R335	
2007 - 000161	R - CHIP 82 K 1/16 W	R166	
2007 - 002797	R - CHIP 560 1/16 W	R452	
2007 - 002965	R - CHIP 15 1/16 W	R313	
2007 - 007001	R - CHIP 3.9 K 1/16 W	R160 R161 R179	
2007 - 007131	R - CHIP 13 K 1 % 1/16 W	R488	
2007 - 007132	R - CHIP 15 K 1/16 W	R489	
2007 - 007133	R - CHIP 300 1/16 W	R404	
2007 - 007480	R - CHIP 130 K 1 % 1/16 W	R101	
2007 - 007529	R - CHIP 91 K 1 % 1/16 W	R102	
2203 - 000138	C - CHIP 1.5 nF	R363	
2203 - 000233	C - CHIP 100 PF	C145 C185 C345 C370 C331	
2203 - 000233	C - CHIP 100 PF	C334 C347 C359 C491 C493	
2203 - 000233	C - CHIP 100 PF	C360 C361 C362 C411 C451	
2203 - 000233	C - CHIP 100 PF	C348 C417 CX501 CX102	
2203 - 000233	C - CHIP 100 PF	C501 CX502 CX503 CX504	
2203 - 000233	C - CHIP 100 PF	C306 C307 C309	
2203 - 000254	C - CHIP 10 nF	C112 C111 C102	
2203 - 000254	C - CHIP 10 nF	C326 C308 C388 C437	

SEC CODE	DESCRIPTION	PART NO.	REMARK
2203 - 000254	C - CHIP 10 nF	C354 C355 C356 C358 C381	
2203 - 000254	C - CHIP 10 nF	C386 C333 C371 C394 C343	
2203 - 000254	C - CHIP 10 nF	C121 C349 C461 C403 C475	
2203 - 000254	C - CHIP 10 nF	C477 C429 C425 C423 C435	
2203 - 000254	C - CHIP 10 nF	C433 C431 C452 C495 C490	
2203 - 000254	C - CHIP 10 nF	C457 C492 C481 C487 C471	
2203 - 000254	C - CHIP 10 nF	C100 C179 C177 C169 C171	
2203 - 000254	C - CHIP 10 nF	C175 C126 C152 C207 C110	
2203 - 000254	C - CHIP 10 nF	C441 C418 C472 C473 C484	
2203 - 000254	C - CHIP 10 nF	C486 C443 C483 C455 C470	
2203 - 000254	C - CHIP 10 nF	CX101	
2203 - 000278	C - CHIP 10 PF	C342 C368	
2203 - 000330	C - CHIP 12 PF	C322	
2203 - 000359	C - CHIP 150 PF	C453	
2203 - 000386	C - CHIP 15 PF	C303	
2203 - 000425	C - CHIP 18 PF	C137 C138	
2203 - 000438	C - CHIP 1 nF	C125 C101 C140 C190 C344	
2203 - 000438	C - CHIP 1 nF	C302 C301 C311 C310 C315	
2203 - 000438	C - CHIP 1 nF	C377 C305 C336 C338	
2203 - 000438	C - CHIP 1 nF	C450 C414 C428 C426 C424	
2203 - 000438	C - CHIP 1 nF	C422 C436 C434 C432 C430	
2203 - 000438	C - CHIP 1 nF	C496 C442 C459 C460 C464	
2203 - 000438	C - CHIP 1 nF	C419 C454 C408 CX001	
2203 - 000438	C - CHIP 1 nF	C113 C327	
2203 - 000466	C - CHIP 1 PF	C317 C332 C325 C420	
2203 - 000489	C - CHIP 2.2 nF	C148 C402	
2203 - 000585	C - CHIP 220 PF	C124 C387 C139 C195	
2203 - 000628	C - CHIP 22 PF	C314 C328	
2203 - 000696	C - CHIP 2 PF	C456	
2203 - 000714	C - CHIP 3.3 nF	C117	
2203 - 000854	C - CHIP 39 PF	C404 C405 C412 C413	
2203 - 000870	C - CHIP 3 PF	C319 C320 C341 C316	
2203 - 000940	C - CHIP 470 PF	C144 C335 C329	

SEC CODE	DESCRIPTION	PART NO.	REMARK
2203 - 000940	C - CHIP 470 PF	CX002 CX103	
2203 - 000941	C- CHIP 470 PF	C149	
2203 - 000995	C - CHIP 47 PF	C463 C458	
2203 - 001033	C - CHIP 5.6 nF	C153	
2203 - 001086	C - CHIP 5 PF	L301	
2203 - 001124	C - CHIP 680 PF	C132 C133	
2203 - 001153	C - CHIP 68 PF	C337 C404 C405	
2203 - 001210	C - CHIP 8.2 nF	C438 C421	
2203 - 001259	C - CHIP 8 PF	C313	
2203 - 001385	C - CHIP 1.5 PF	C462	
2203 - 001405	C - CHIP 22 nF	C141 C142 C154	
2203 - 001416	C - CHIP 33 nF	C415	
2203 - 001432	C - CHIP 47 nF	C365 CX106	
2203 - 001385	C - CHIP 4.7UF	C164	
2203 - 002687	C - CHIP 1.2 nF	C131	
2203 - 003054	C - CHIP 9 PF	C304	
2203 - 005052	C - CHIP 3.3PF	C406	
2203 - 005061	C - CHIP 100 nF	C176 C174 C178 C170 C172	
2203 - 005061	C - CHIP 100 nF	C173 C168 C129 C114 C128	
2203 - 005061	C - CHIP 100 nF	C146 C136 C205 C202 C203	
2203 - 005061	C - CHIP 100 nF	C184 C116 C118 C157	
2203 - 005061	C - CHIP 100 nF	C127 C106 C108 C120 C122	
2203 - 005144	C - CHIP 1 UF	C130 C143 C150 C151	
2404 - 000139	C - TA 10 UF 6.3 V	C107 C109 C312 C330 C389	
2404 - 000139	C - TA 10 UF 6.3 V	C439 C401 C488 C485 C353	
2404 - 000139	C - TA 10 UF 6.3 V	C357 C474 C476	
2404 - 000151	C - TA 1 UF 16 V	C410 C165	
2404 - 000167	C - TA 2.2 UF 16 V	C134 C482	
2404 - 000259	C - TA 47 UF 6.3 V	C440	
2404 - 000274	C - TA 1.5 UF 16 V	C416	
2404 - 000312	C - TA 470 nF 16 V	C350	
2404 - 001032	C - TA 33 UF 6.3 V	C123 C382	
2404 - 001064	C - TA 10 UF 6.3 V	C346	
2703 - 000109	INDUCTOR 100 nH	L404 L309	

SEC CODE	DESCRIPTION	PART NO.	REMARK
2703 - 000237	INDUCTOR 750 nH	L403	
2703 - 000261	INDUCTOR 390 nH	L311	
2703 - 000300	INDUCTOR 1 UH	L455 L305 L314 L343 L346	
2703 - 000300	INDUCTOR 1 UH	L342	
2703 - 000301	INDUCTOR 2.7 UH	L312 L344	
2703 - 001011	INDUCTOR 100nH	L402	
2703 - 001040	INDUCTOR 10nH	L454	
2703 - 001167	INDUCTOR 8.2 nH	L341	
2703 - 001172	INDUCTOR 100 nH	L458 L303 L317	
2703 - 001173	INDUCTOR 12 nH	L451	
2703 - 001175	INDUCTOR 56 nH	L355 L356	
2703 - 001179	INDUCTOR 10 nH	L351 L354	
2703 - 001181	INDUCTOR 27 nH	L316	
2703 - 001189	INDUCTOR 18 nH	C391	
2703 - 001263	INDUCTOR 4.7 nH	C446	
2703 - 001284	INDUCTOR 5.6 nH	L302 C391	
2703 - 001306	INDUCTOR 27 nH	L453 L456	
2703 - 001409	INDUCTOR 12 nH	L306 C115	
2703 - 001543	INDUCTOR 33 nH	L401	
2703 - 001563	INDUCTOR 10 uH	L101	
2703 - 001613	INDUCTOR 18 nH	L304	
2703 - 001693	INDUCTOR 330 nH	L310	
2802 - 001048	RESONATOR 27 MHz	X101	
2806 - 001146	OSCILLATOR - VCO	U341	
2809 - 001208	OSCILLATOR - VCTCXO 19.68MHz	U343	
2904 - 000297	FILTER - SAW 85.38 MHz	F303	
2904 - 001011	FILTER - SAW 881.5 MHz	F302	
2904 - 001012	FILTER - SAW 836.5 MHz	F451	
2904 - 001004	FILTER - DUPLEXER 881 MHz	F301	
3710 - 001105	CONNECTOR - SOCKET 2 P	J102	
3710 - 001117	CONNECTOR - SOCKET 24 P	CON100	
3710 - 001302	CONNECTOR - SOCKET 18 P	J101	
3722 - 001172	JACK POWER	J104	
GH07 - 20551A	DISPLAY	LCD	
GH39 - 20013A	CBF - SIGNAL	-	
GH71 - 10680A	NPR - ANT,LING		

8. Troubleshooting

8-1 Logic Section

8-1-1 No Power

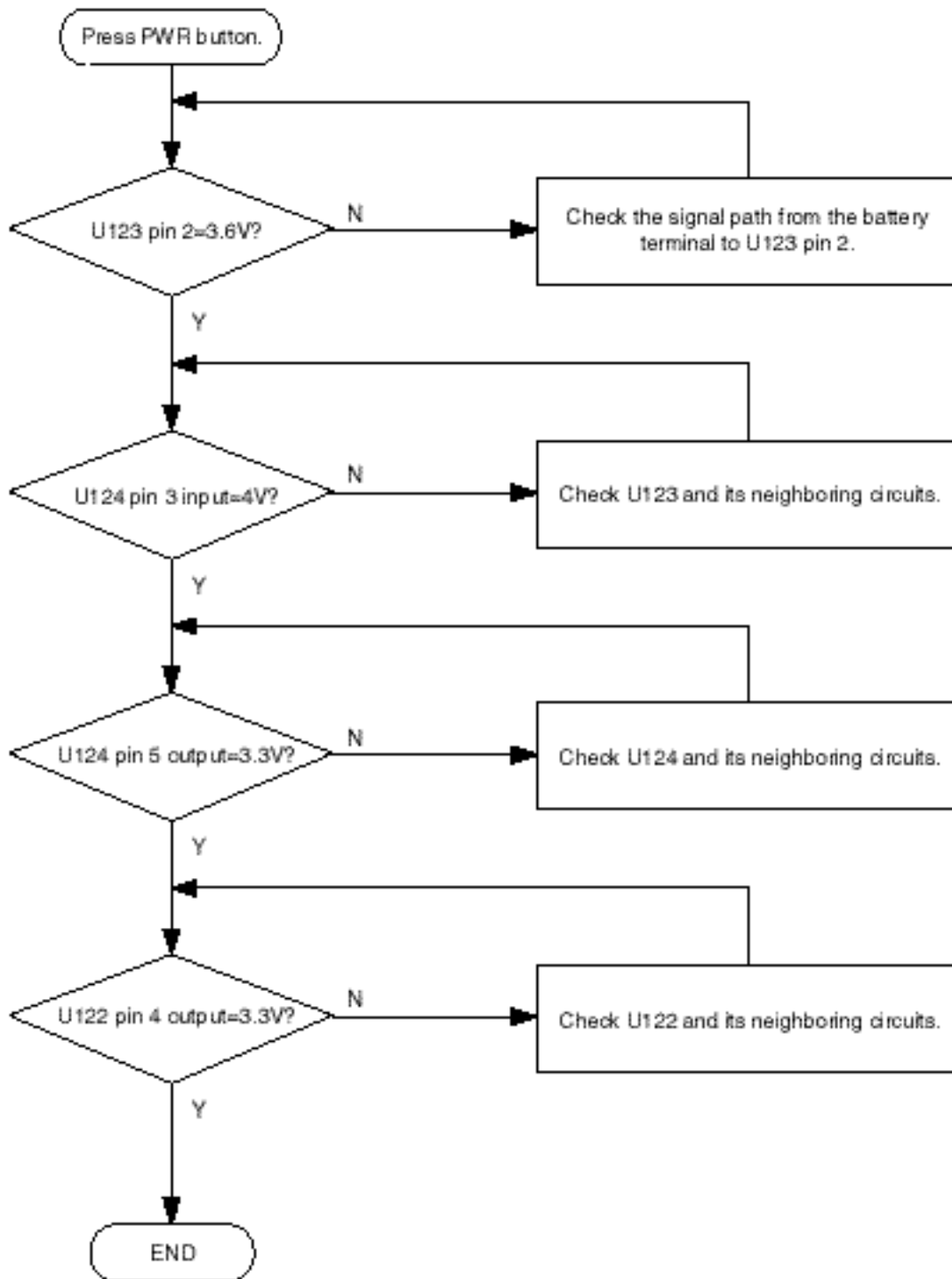

8-1-2 Abnormal Initial Operation (Normal +3.3V voltage source)

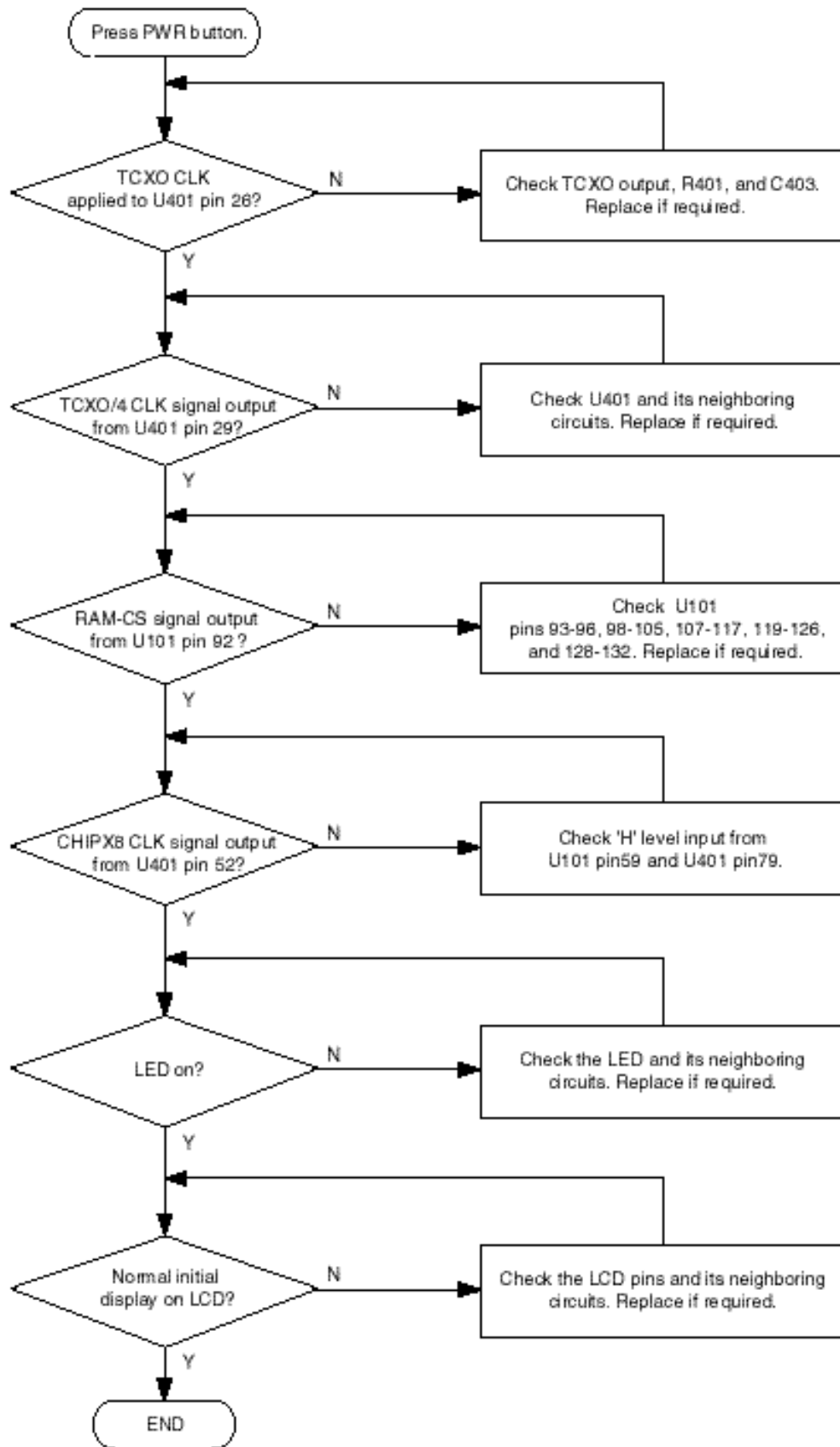

8-1-3 Abnormal Backlight Operation

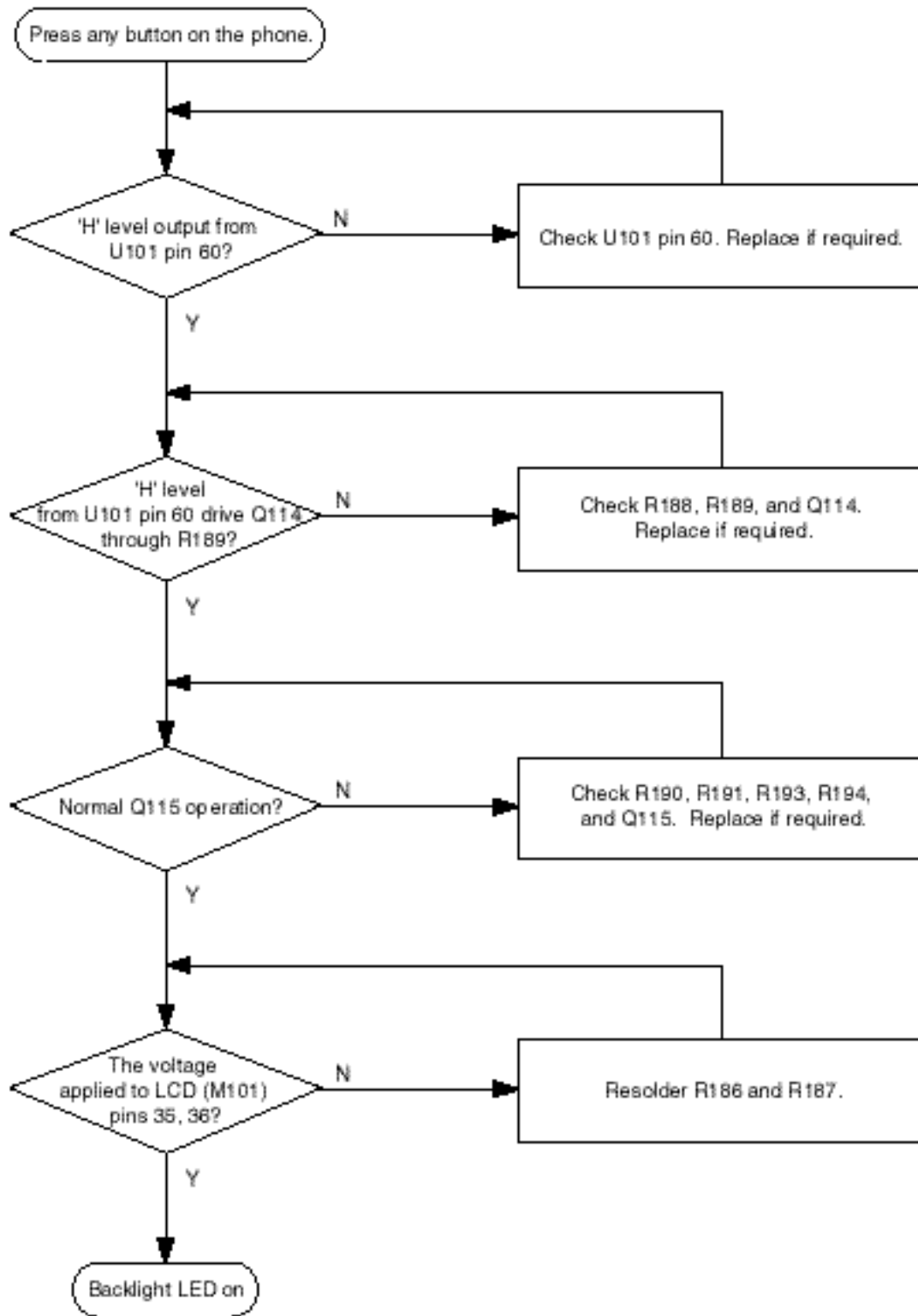

8-1-4 Abnormal Key Data Input

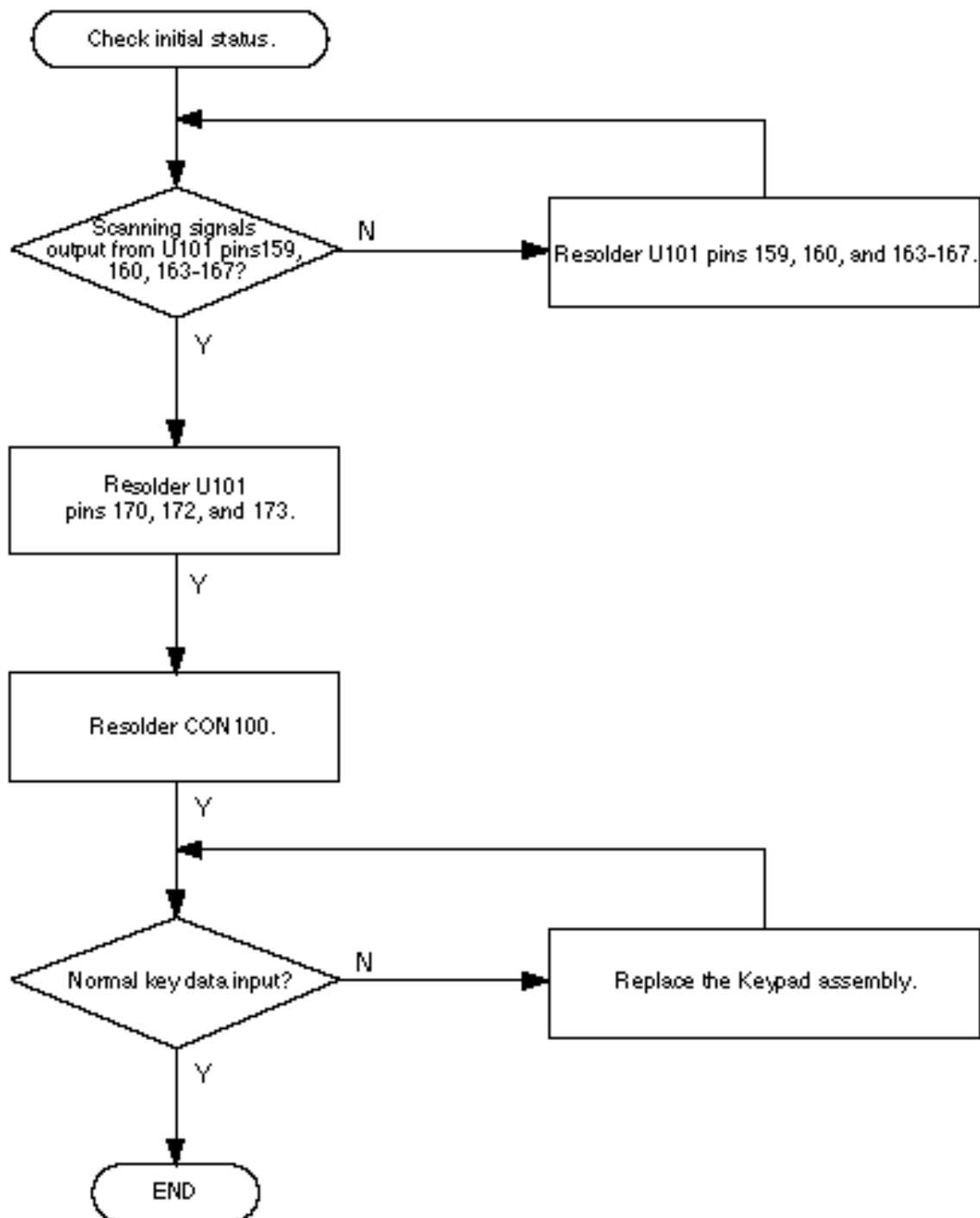

8-1-5 Abnormal Keytone

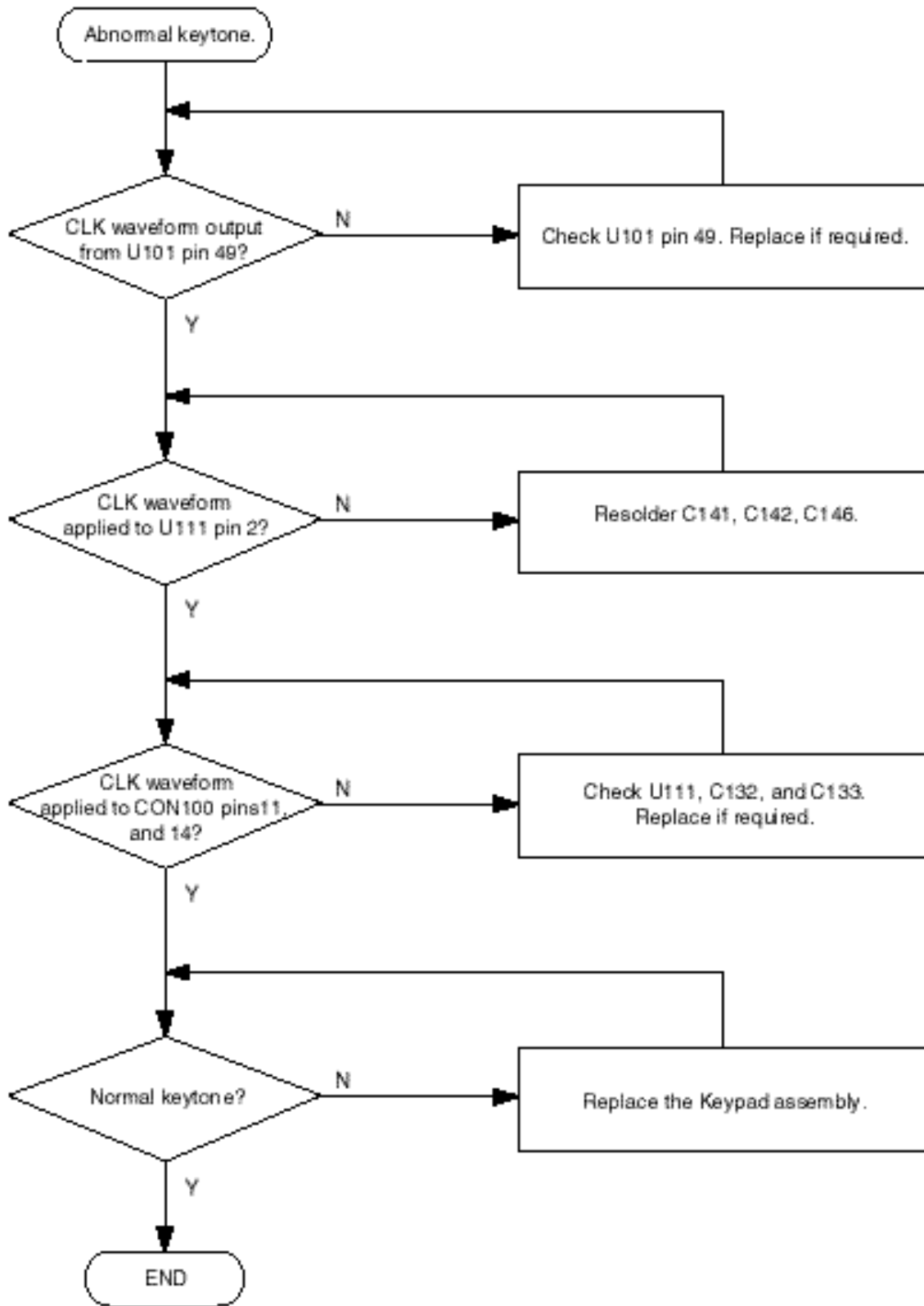

8-1-6 Abnormal Alert Tone

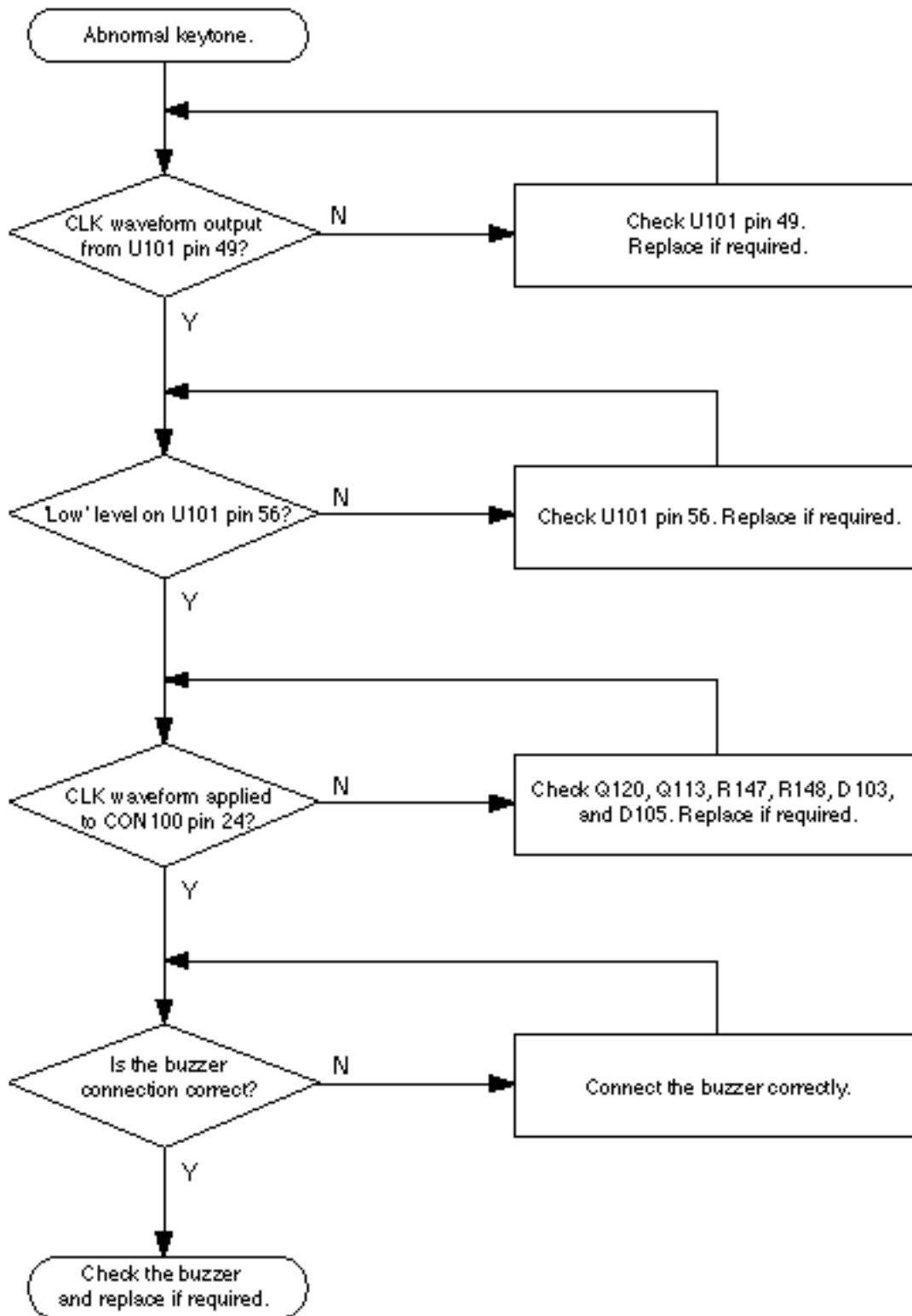

8-2 RF Section

8-2-1 RF Section Troubleshooting

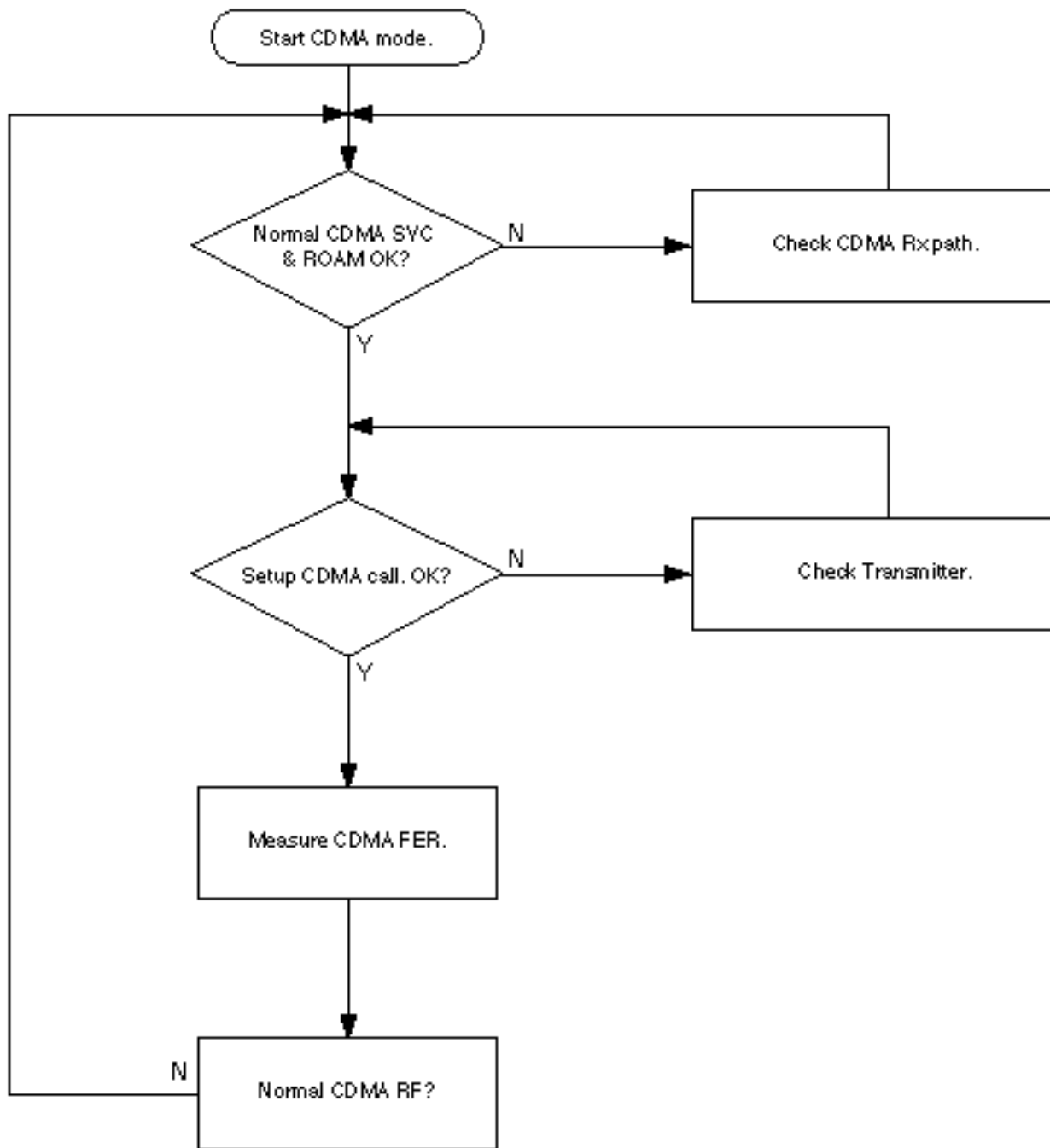

8-2-2 Receiver Part

.

8-2-3 Transmitter Part

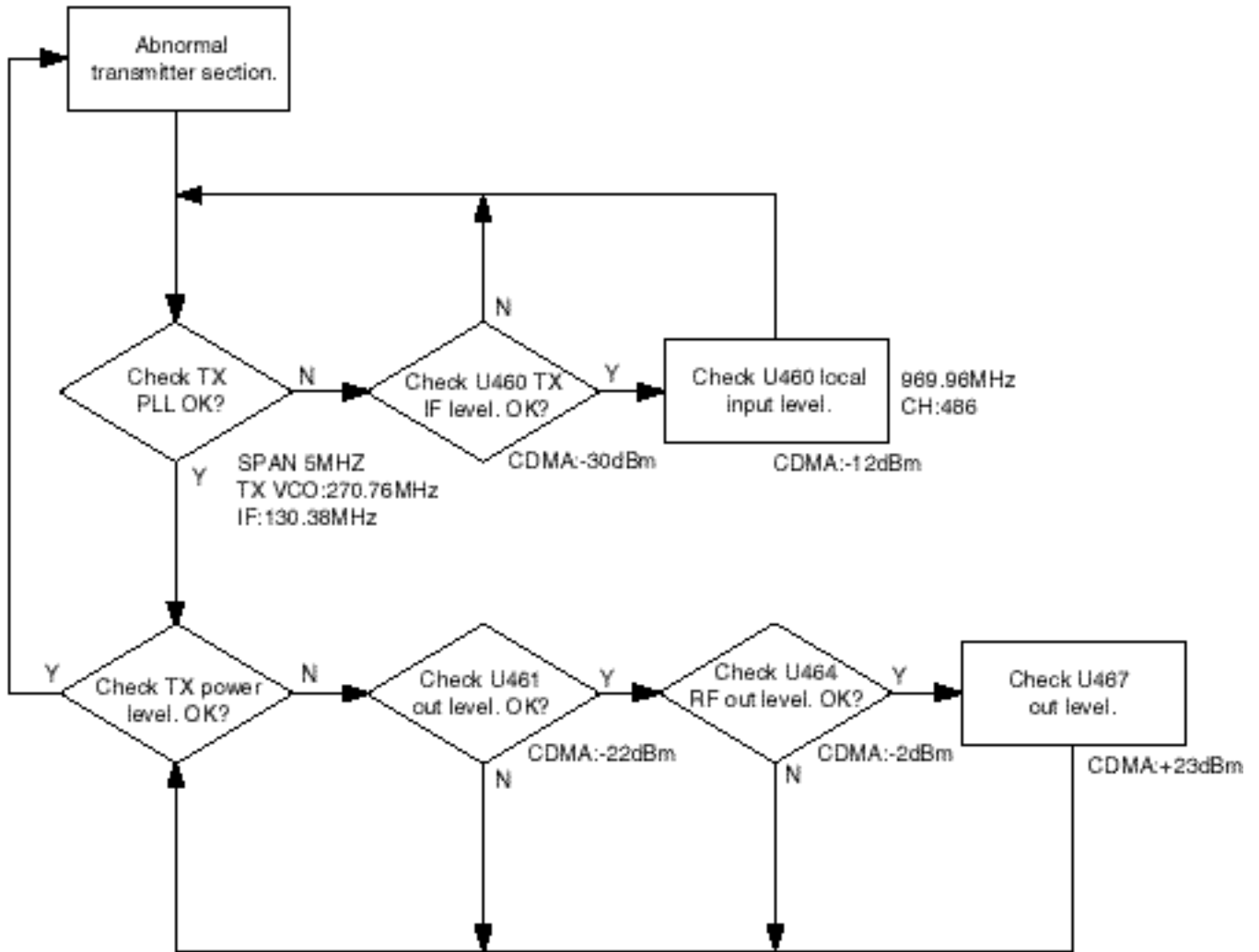

10. Block & Circuit Diagrams

10-1 Block Diagram

